



PREMIUM TIMBER SOLUTION

De 25 ani, numele TEHNICAS reprezinta constientizarea calitatii lemnului, fiabilitatea maxima si maiestria in prelucrarea cherestelei laminate lipite. Suntem specializati in productia si prelucrarea structurilor din lemn atat pe partea de tamplarie conventionala cat si pe partea structurilor complexe de inginerie din lemn.

INOVATIE PRIN COOPERARE

Cu o vechime considerabila pe piata din Romania, suntem un producator de lemn lamelat inleiat la cele mai inalte standarde. Credem in cooperare si ii adaptam principiile ca motor al inovatiei.

Suntem o afacere de familie cu o experienta de 4 generatii, ceea ce ne determina sa ne respectam munca.

VIITORUL ESTE CONSTRUIT PE LEMN

Utilizarea lemnului in constructii este o modalitate durabila, estetica si eficienta din punct de vedere energetic de a construi cladiri in viitor.

Maiestria, tehnologia si pasiunea noastra ne permite sa creem constructii moderne din punct de vedere arhitectural si durabile din punct de vedere structural.





TOTUL INTR-UN SINGUR LOC



Consultanta & Proiectare



Productie Lemn Lamelat Incleiat



Prelucrare Manuala & Robotica

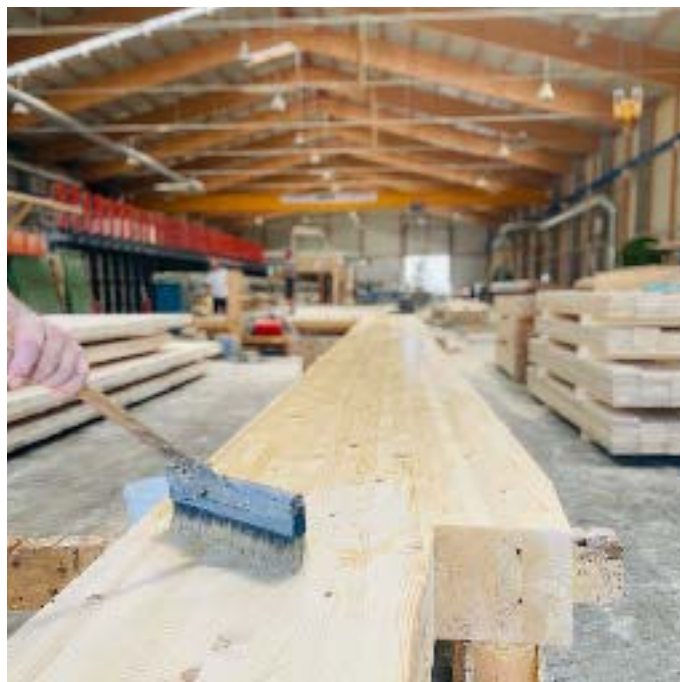

Protectia si tratarea de suprafata



Logistica & Livrare



Asistenta montaj & Montaj

CUNOSTINTELE NECESARE

Multi dintre angajatii nostri sunt alaturi de noi inca de la inceput. Ei isi cunosc profesia, intelegand nevoile si dorintele clientilor, astfel sunt capabili sa isi indeplineasca sarcinile intr-un mod eficient si precis.

STRUCTURI OPTIMIZATE ECONOMIC

Folosim modelarea 3D -CAD si BIM in Software CADWORK pentru proiectarea si testarea solutiilor tehnice adaptate cerintelor proiectului si nevoilor dumneavoastra. Imbinam perfect structura de rezistenta cu estetica.

Cunoastem lemnul si avem resursele necesare pentru a exploata acest material in vederea realizarii unor constructii durabile, personalizate si cu un aspect estetic impecabil.

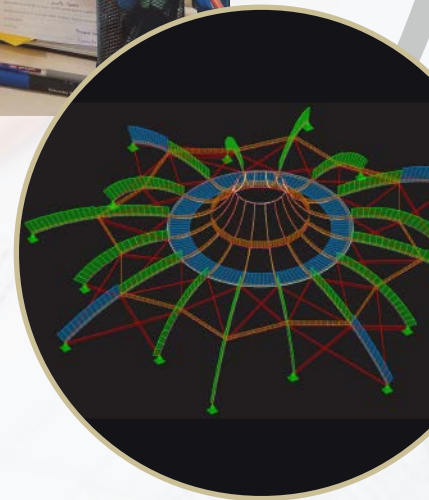
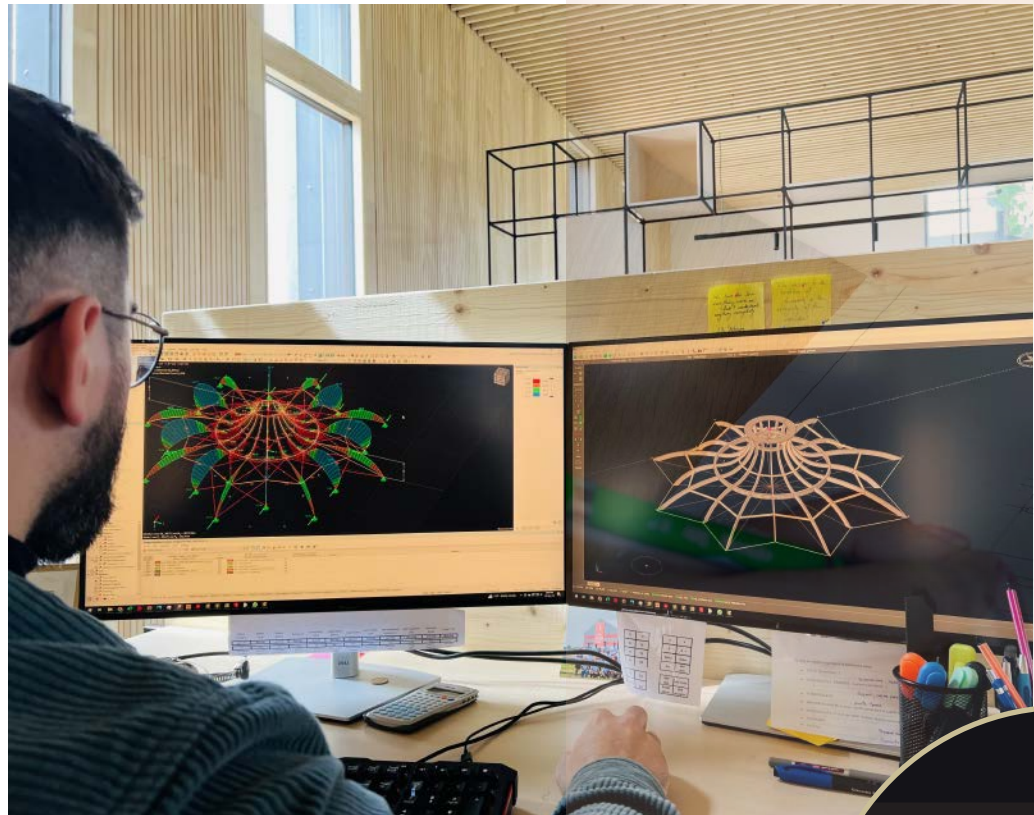

CALCUL STATIC

DETALII ELEMENTE STATICE



PLANURI DE PRELUCRARE SI PRODUCTIE



PROIECTARE 3D- CADWORK

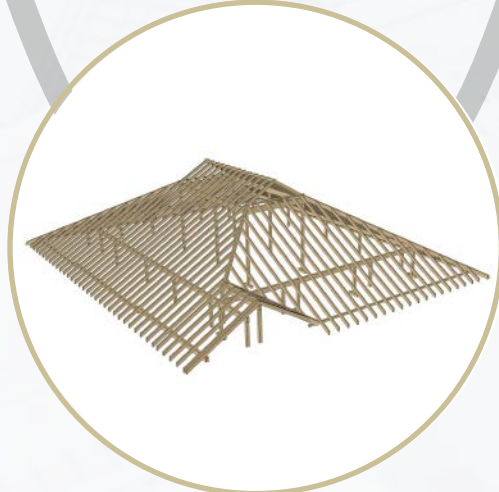

PLANURI MONTAJ

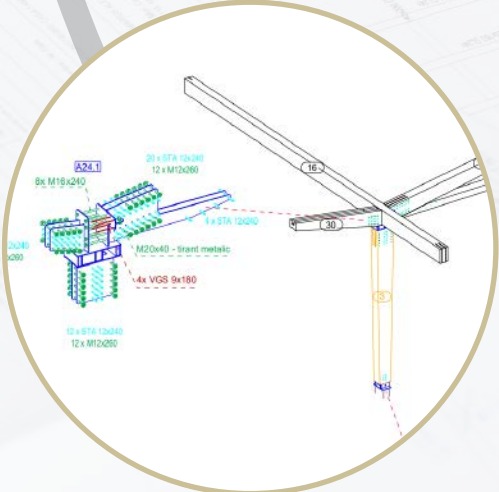

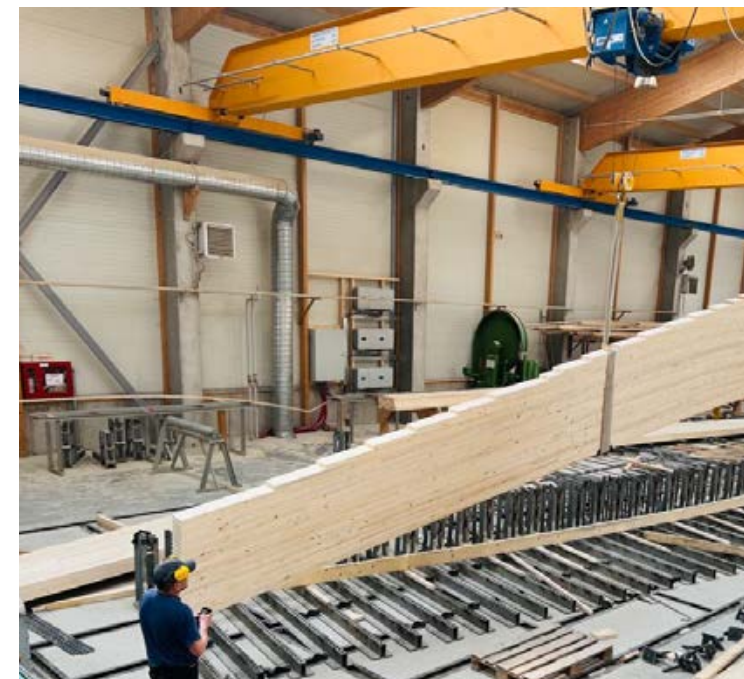
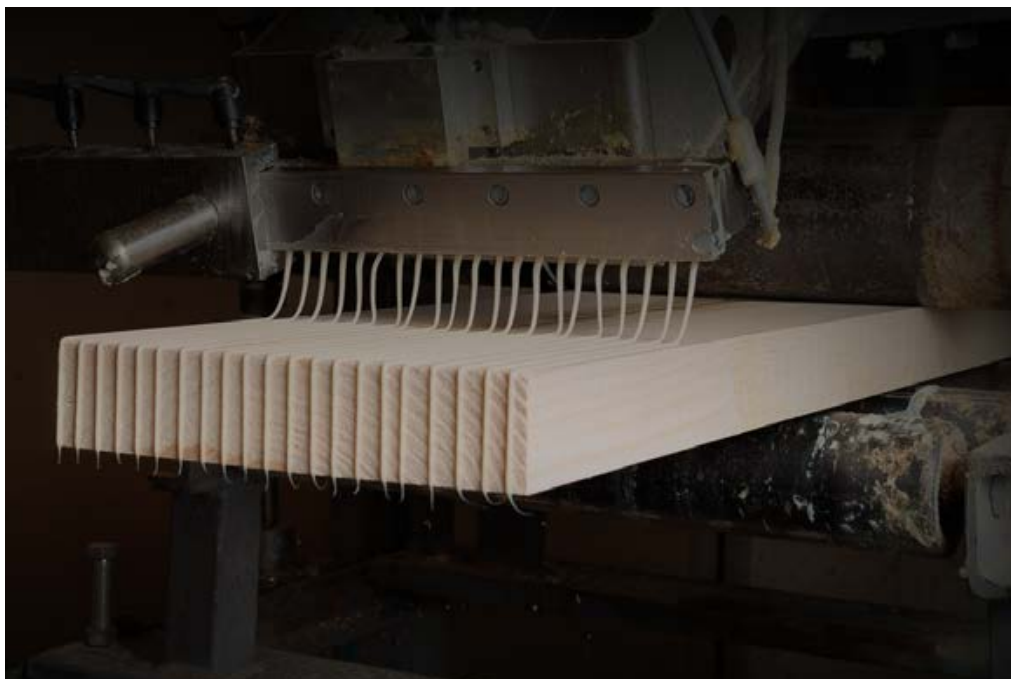

PRODUCTIE PERSONALIZATA

In fiecare zi producem aproximativ 50mc lemn lamelat incleiat in diferite forme si aspecte si il livram in conformitate cu specificatiile dumneavoastra.

Gama noastra include BSH, DUO, KVH si ARC elemente speciale, este extrem de vasta si poate fi adaptata pentru a satisface o varietate de nevoi si aplicatii de constructie. Acestea se preteaza atat pentru variante aparente cat si industriale.

INGINERIE DIN LEMN PENTRU TOTI

Componentele din lemn stratificat pe care le producem respecta cele mai inalte standarde de calitate din industria Romaniei. Pastram calitatea in procesul de productie, astfel mentinem o durata de viata prelungita iar aspectul componentelor este unul estetic si atractiv.



TEHNICAS

FURNIZORUL DUMNEAVOASTRA DE
LEMN ACUM SI MAI PUTERNIC.



PRELUCRAREA MANUALA

Prelucrarea manuala a lemnului necesita abilitatea si experienta in lucrul cu instrumentele manuale precum si tehnici de prelucrare pe care dulgherii nostrii le stapanesc foarte bine. Procesul de dulgherie manuala este mai lent si mai intens decat ulizarea robotilor de dulgherie.

AUTOMATIZAT CU FLEXIBILITATE MAXIMA

HUNDEGGER Robot-Drive 1300 prelucreaza lemnul lamelat incleiat cu precizie iar abaterile maxime sunt de ordinul milimetrilor. Robotul de tamplarie este proiectat pentru a fi eficient, precis si flexibil. Acesta poate fi programat sa produca o gama larga de elemente si forme diferite, iar utilizarea lui reduce semnificativ timpul si costurile de productie. De asemenea, robotii de tamplarie pot fi utilizati pentru a prelucra lemnul intr-un mod mai sigur, eliminand astfel riscurile asociate cu utilizarea uneltelor de tamplarie traditionale.

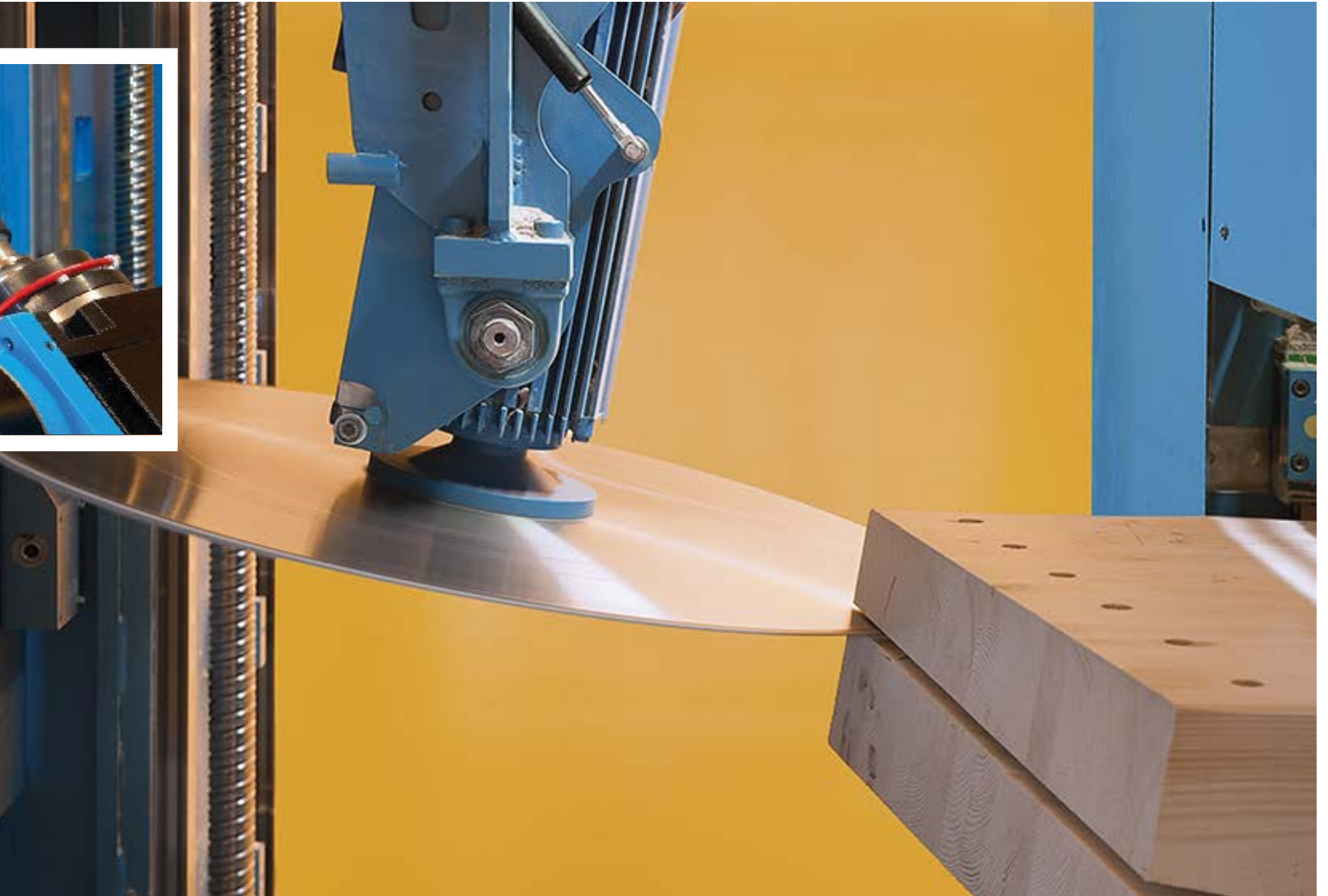



CONSULTANTA



PREFABRICARE

COLLAB

PROIECTARE



“De la conceptul structurii de suport pana la logistica de santier”

ORARE



LOGISTICA

PRELUCRARE

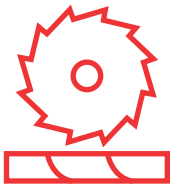

ASISTENTA LA MONTAJ





TURN DE OBSERVARE



DETALIU IMBINARE



TERASA NUBA



CENTRUL REFORMAT NOUL MILENIU



HORSES NEST



ACOPERIS BISERICA

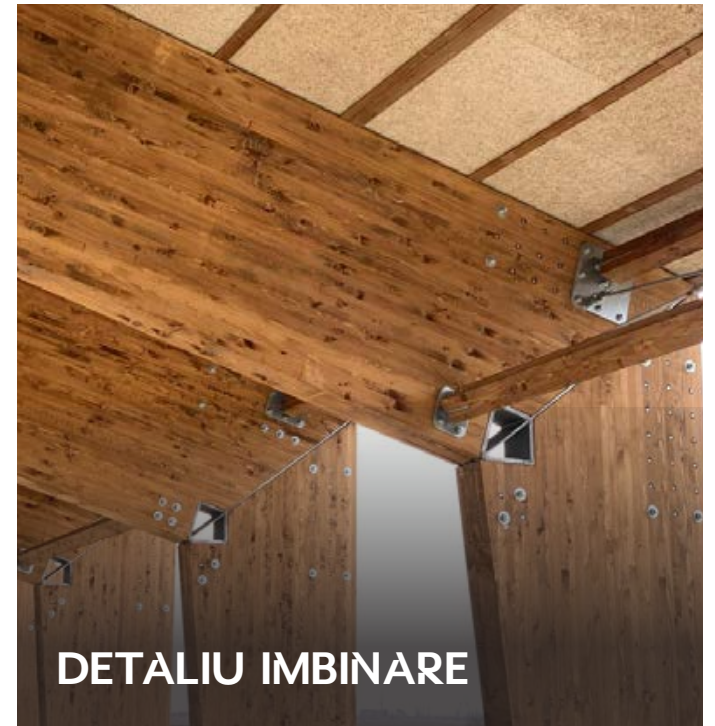

DETALIU IMBINARE



Voiteg 307470,
Timis, Romania

info@tehnicas.ro
www.tehnicas.ro

T: 0256 39 25 77